

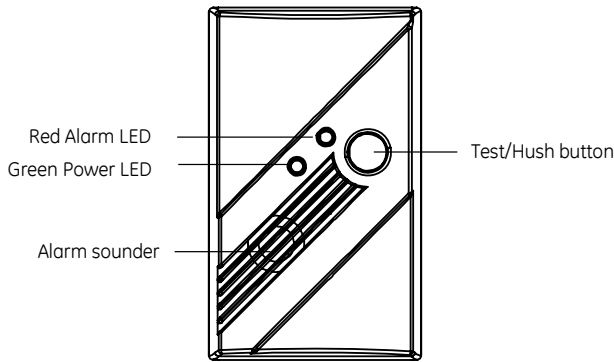

TX-6310-01-1 Carbon Monoxide Alarm Manual

Figure 1: Alarm features



Attention: Please take a few minutes to thoroughly read this guide which should be saved for future reference and passed on to any subsequent owner.

The TX-6310-01-1 CO alarm is only compatible with Simon XT panels with firmware v1.4 or higher. Refer to the panel installation instructions for revision verification details. It is currently not compatible with other control panels. Please contact Technical Support for any questions regarding compatibility.

Description

The TX-6310-01-1 wireless carbon monoxide (CO) alarm monitors the levels of CO gas and gives early warning when potentially dangerous levels exist. It does not detect fire, smoke, or any other gas. If a dangerous concentration of CO is detected by patented and field-proven electrochemical sensor, an LED indicator illuminates and an internal siren is activated in temporal 4 pattern. The CO alarm also transmits an alarm signal to the control panel within 15 seconds of detecting dangerous concentration of CO gas. The control panel activates its internal siren and reports the alarm condition to the central monitoring station (if the system is monitored). The CO alarm also detects low battery, wall tamper, and sensor end-of-life. These trouble codes are transmitted to the control panel which reports the condition to the central monitoring station. The alarm automatically reset when CO is no longer detected.

The TX-6310-01-1 wireless CO alarm is Listed and compliant with the ANSI/UL 2034 standard for CO alarms. It is intended for residential indoor dwelling unit applications and other areas approved by the authority having jurisdiction (AHJ). It is not intended for use in industrial applications.

WARNING: After seven years from initial power up, this alarm will beep two times every 30 seconds to indicate that it is time to replace the alarm. Replace the alarm immediately! It will not detect CO in this condition.

To help identify the date to replace the alarm, an area has been reserved on the side of the alarm. Write the “replace by” date (seven years from power up) with a permanent marker in the area provided.

Alarm location

CO alarms should be mounted in or near bedrooms and living areas. We recommend that you install an alarm on each level of your home.

When choosing your installation locations, make sure you can hear the alarm from all sleeping areas. If you install only one CO alarm in your home, install it near bedrooms, not in the basement or furnace room.

Place the alarm out of reach of children. Under no circumstances should children be allowed to handle the CO alarm.

Figure 2: Recommended locations

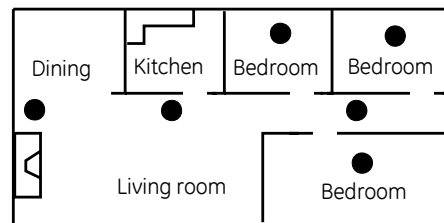

Locations to avoid

Improper location can affect the sensitive electronic components in this alarm. To avoid causing damage to the unit, to provide optimum performance, and to prevent unnecessary nuisance alarms:

- Do not install in kitchens, garages, or furnace rooms that may expose the sensor to substances that could damage or contaminate it.
- Do not install in areas where the temperature is colder than 40°F (4.4°C) or hotter than 100°F (37.8°C) such as crawl spaces, attics, porches, and garages.
- Do not install within 5 ft. of heating or cooking appliances. (We recommend 15 ft. to prevent nuisance alarms.)

- Do not install near vents, flues, chimneys, or any forced/unforced air ventilation openings.
- Do not install on metal surfaces.
- Avoid mounting in areas with a large quantity of metal or electrical wires.
- Do not install near ceiling fans, doors, windows, or areas directly exposed to the weather.
- Do not install in dead air spaces, such as peaks of vaulted ceilings or gabled roofs, where CO may not reach the sensor in time to provide early warning.
- Do not install near deep-cell large batteries. Large batteries have emissions that can cause the alarm to perform at less than optimum performance.
- Do not obstruct the vents located on the alarm. Do not place the alarm where drapes, furniture, or other objects block the flow of air to the vents.

Battery installation and replacement

Note: Place the control panel into sensor test mode prior to replacing the batteries. If the control panel is not in sensor test mode during battery replacement, an alarm/tamper condition may be indicated.

To install or replace the batteries in this alarm:

1. Slide the alarm body off of the mounting plate.
2. If replacing batteries, remove the old batteries and properly dispose of them as recommended by the battery manufacturer.
3. Install the new batteries. Note the polarity illustration in the battery compartment (see Figure 3 below).

Figure 3: Batteries

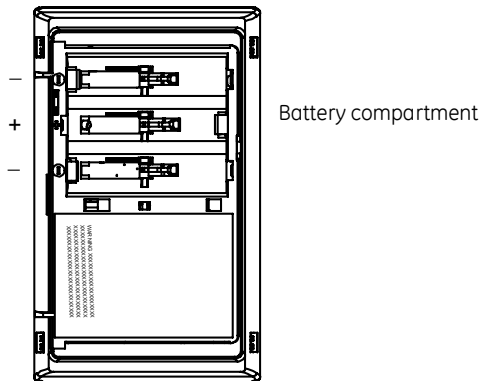

4. Slide the alarm body back onto the mounting plate.

Note: The mounting plate will not close if all three batteries are not installed.

Figure 4: Sliding the alarm on the mounting plate

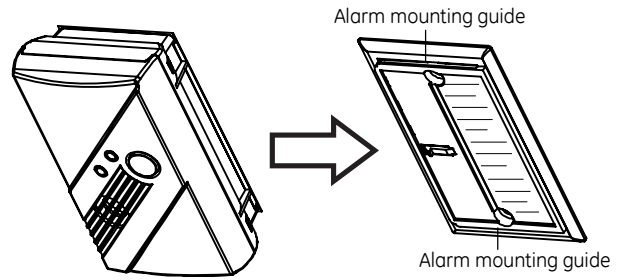

5. Perform a sensor/RF test with the control panel. See "RF communication test" on page 3

When replacing the batteries, use one of the following approved brands:

- Duracell MN1500 or MX1500
- Energizer E91

Note: For battery replacement information, see interlogix.com.

Use of a different battery may have a detrimental effect on the alarm operation.

Note: Constant exposures to high or low humidity may reduce battery life.

After installing or changing the batteries, reinstall your alarm. Test your alarm by using the Test/Hush button and check that the green Power LED is on.

Mounting the alarm

Note: Verify RF performance prior to permanently mounting the alarm. See "RF communication test" on page 3.

The CO alarm can be wall mounted or ceiling mounted.

To mount the alarm:

1. Slide the alarm body off of the mounting plate. Place the mounting plate in the desired location, and mark the location of the two mounting holes. Orient the mounting plate vertically or horizontally as shown in the following figures.

Note: The alarm can also be directly mounted to a single gang box.

Figure 5: Vertical mounting

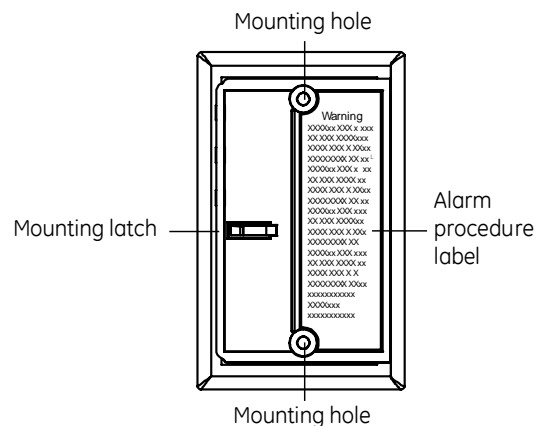
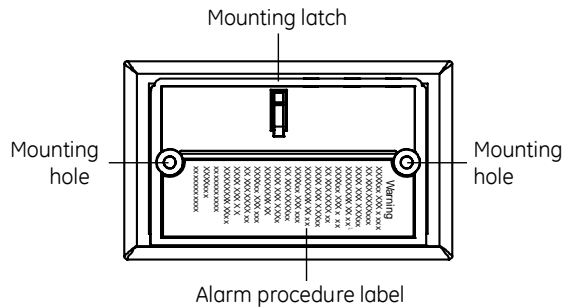

Figure 6: Horizontal mounting



2. Insert the two screws provided and secure the mounting plate to the wall or ceiling surface. (If mounting in plasterboard or drywall, drill a 3/16 in. hole and use the plastic anchors provided.)
3. After the mounting plate is secured, slide the alarm over the mounting plate (see Figure 4 on page 2).

Important labels provided

Two labels have been provided that have important information on what to do in case of an alarm. Add the phone number of your emergency service provider in the space provided. Place one label next to the alarm after it is mounted, and one label near a fresh air source such as a door or window.

Programming

The following section provides a general guideline for programming (learning) the unit into control panel memory. Refer to the panel documentation for complete programming details.

To add the CO alarm to panel memory:

1. Set the panel to program mode.
2. Proceed to the Learn/Add Sensors menu.
3. Select the desired sensor number.
4. Trip the wall tamper by removing the alarm body from the mounting plate.
5. When the panel prompts you for sensor group number, enter the appropriate group number based on the system panel.
6. At the panel, exit program mode.
7. Place the alarm body back onto the mounting plate.

Note: Each CO alarm is programmed with a unique ID when manufactured. The unique ID is enrolled into the control panel at the time of installation, allowing the CO alarm to communicate with that specific control panel.

Testing

Note: This unit is sealed. The cover is not removable.

WARNING: The control panel must be placed into sensor test mode while conducting any tests. Placing the control panel into sensor test mode for all testing helps to protect against false alarms and unintentional central station reporting.

Due to the loudness of the alarm, we suggest that you place your fingers over the sounder vent while testing your alarm.

Caution: Continuous exposure to the high sound level of this alarm over an extended period of time may cause hearing loss.

The CO alarm provides three test modes:

- **Normal CO alarm test.** Conducts an internal self test and tests the sounder.
- **RF communication test.** Tests the communication path with the control panel.
- **CO alarm functional gas test.** Tests the functional operation of the CO sensing element.

Normal CO alarm test

1. Wait at least 10 minutes after installation to test the CO alarm.
2. Make sure the green Power LED is flashing for normal operation.
3. Set the control panel to sensor test mode.
4. Press and hold the Test/Hush button until the unit beeps once (approximately 1 second), and then release the button. If the unit is operating properly, you will hear four quick beeps, followed by 5 seconds of silence, followed by four quick beeps.
5. At the control panel, exit sensor test mode.

Note: This test mode does not test communication with the control panel. You will receive a "Sensor Test Fail or Abort" message when the control panel exits sensor test mode.

RF communication test

This section provides general guidelines for testing the CO alarm with the panel. Refer to the specific panel documentation for complete testing details.

Before testing, ensure that your control panel is set to sensor test mode. Setting your panel to sensor test mode prevents an alarm signal from being transmitted to the central monitoring station (if you have a monitored system).

1. Wait at least 10 minutes after installation to test the CO alarm.
2. Make sure the green Power LED is flashing for normal operation.
3. Set the control panel to sensor test mode.
4. Press and hold the Test/Hush button until the unit beeps two times (approximately 5 seconds), and then release the button. If the unit is operating properly, you will hear four quick beeps. The unit will send the RF test packets after the first four beeps.
5. The control panel will beep and display the number of RF packets received.
6. At the panel, exit sensor test mode.

CO inspection and functional gas test (for qualified service technicians only)

Note: Consult the most recent version of NFPA 720 for more information regarding the requirement for functional testing of CO alarms and/or your Local Authority Having Jurisdiction (AHJ).

A canned CO testing agent must be used for the CO functional gas test.

1. Wait at least 10 minutes after installation to test the CO alarm.
2. Make sure the green Power LED is flashing for normal operation.
3. Set the control panel to sensor test mode.
4. Press and hold the Test/Hush button until the unit beeps three times (approximately 10 seconds), and then release the button. The unit will enter the functional gas test mode. The Power LED will blink once per second while in functional test mode.
5. Apply UL approved CO test agent to the slit as shown in Figure 7 below. When CO is detected, the unit will activate a CO alarm. The unit will send RF test packets to the control panel when the CO alarm is activated.

Figure 7: CO testing slit

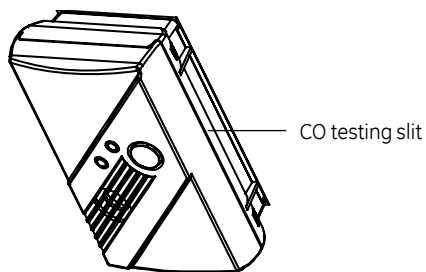

6. The control panel will beep and display the number of RF packets received.
7. At the control panel, exit sensor test mode.
8. Exit functional gas test mode:
Press and release the Test/Hush button; or
A 2 minute timeout will automatically cause the CO to return to normal operating mode.

Troubleshooting

This information is provided to help you diagnose and solve various problems that may arise while configuring or using the wireless CO alarm.

Unit does not power up properly or reports low battery:

- Make sure the batteries are fully seated within the battery compartment and the polarity is correct.
- Make sure that all three batteries are installed.
- Check the battery voltage (1.5 VDC nominal per battery).

Control panel does not respond:

- Use the 60-401 RF Sniffer to make sure the CO alarm is sending messages for activation.
- Move or rotate the CO alarm position.
- Make sure the CO alarm is properly enrolled into the control panel.
- Make sure that you are using a compatible control panel (see “Specifications” below).

Tamper condition does not restore:

- Make sure the CO alarm body is properly installed on the mounting plate.
- Make sure there are no trouble indications at the CO alarm.
- Make sure that you are using a compatible control panel (see “Specifications” below).

If a tamper alarm occurs:

- Make sure that you are using a compatible control panel (see “Specifications” below).
- Make sure that the control panel is in sensor test mode during sensor testing.

Alarm/open condition does not restore:

- Make sure that the CO alarm condition has cleared at the CO alarm.
- Make sure that you are using a compatible control panel (see “Specifications” below).

Specifications

| | |
|-----------------------|---|
| Compatible panels | Simon XT (firmware 1.4 or greater) from UTC Fire & Security |
| Power | Three AA batteries |
| Battery type | 1.5 VDC alkaline |
| Required batteries | Duracell MN 1500, Duracell MX1500, Energizer E91 |
| Sensor | Electrochemical |
| Sensor life | 7 years |
| Frequency | 319.5 MHz |
| Supervisory interval | 64 minutes |
| Audible alarm | Temporal 4 |
| Alarm response times | 70 PPM = 60-240 min. 150 PPM = 10-50 min. 400 PPM = 4-15 min. |
| Dimensions | 4.68 x 2.75 x 1.85 in. (119 x 70 x 47 mm) |
| Storage temperature | -4 to 140°F (-20 to 60°C) |
| Operating environment | |
| Temperature | 40 to 100°F (4.4 to 37.8°C) |
| Relative humidity | 10 to 95% noncondensing |

Regulatory information

| | |
|----------------|--|
| ETL rating | ANSI/UL 2034 |
| FCC compliance | This device complies with part 15 of the FCC Rules. Operation is subject to the following two conditions: (1) This device may not cause harmful interference, and (2) this device must accept any interference received, including interference that may cause undesired operation. FCC ID: B4Z-929A-CO |

Operation characteristics

Table 1: Operation characteristics

| | LED Display | Alarm sound | Unit status | Control panel status | Recommendation |
|---------------------------------------|---|---|--|--|--|
| Normal operation | Green Power LED flashes every 30 seconds. | None. | Normal DC operation (sensing no CO) and with good batteries. | Normal operating condition. | None. |
| Carbon monoxide alarm | Red Alarm LED flashes with beeps. | Four quick beeps, 5 seconds silence, repeating. | Alarm condition. Dangerous concentrations of CO detected. | Alarm condition. | See "Alarm procedure" on page 8. |
| Low battery / low battery hush | Red Alarm LED flashes every 60 seconds. | One quick beep every 60 seconds. | Batteries need to be replaced. | Trouble condition, trouble beeps every 60 seconds. | Replace all three AA batteries. Press Test/Hush button and release. This will silence the low battery audible chirp between 8 and 11 hours allowing for a more convenient time to replace the batteries. |
| Alarm end-of-life indicator | Red Alarm LED flashes two times every 30 seconds. | Two quick beeps every 30 seconds. | End of CO alarm life. | Trouble condition, trouble beeps every 60 seconds. | Press the Test/Hush button and release. This will silence the end-of-life signal for up to three days. After three days, the unit will resume end-of-life chirps. Hush mode will silence the alarm ten times or up to 30 days. After 30 days, the unit can no longer be hushed. Replace the CO alarm immediately. The unit will not respond to CO. |
| Trouble/service alarm | Red Alarm LED flashes every 30 seconds. | One quick beep every 30 seconds. | Unit is in trouble condition. | Trouble condition, trouble beeps every 60 seconds. | Replace batteries. If condition continues, unit has malfunctioned. Replace immediately. Unit will not respond to CO. |
| Error condition | Red Alarm LED constantly on. | Constant alarm. | Very low battery or unit malfunction. | Trouble condition, trouble beeps every 60 seconds. | Replace batteries. If condition continues, unit has malfunctioned. Replace immediately. Unit will not respond to CO. |
| Test mode | Red Alarm LED flashes with beeps. | Four quick beeps, 5 seconds silence, repeated once. | Normal operation when Test/Hush button is pressed. | Sensor test mode | CO not detected. Alarm for test purposes only. |
| Tamper | Red Alarm LED flashes every 30 seconds. | One quick beep every 30 seconds. | Unit is in tamper condition. | Trouble condition, trouble beeps every 60 seconds. | Place alarm body back onto mounting plate. If condition continues, unit has malfunctioned. Replace immediately. |

Maintenance tips

To keep your alarm in good working order:

- Perform a CO alarm test once a week (see "Normal CO alarm test" on page 3).
- Vacuum the alarm cover once a month to remove accumulated dust.
- Never use detergents or solvents to clean the alarm. Chemicals can permanently damage or temporarily contaminate the sensor.
- Avoid spraying air fresheners, hair spray, paint, or other aerosols near the alarm.
- Do not paint the unit. Paint will seal the vents and interfere with proper sensor operation.

Move the CO alarm to a remote location, to prevent possible damage or contamination of the sensor, prior to performing any of the following:

- Staining or stripping floors or furniture, painting or wall-papering.
- Using aerosols or adhesives.

WARNING: Reinstall the CO alarm as soon as possible to assure continuous protection.

The following is a list of substances that at high levels can damage the CO sensor or cause temporary readings that are not CO readings:

Ethylene, ethanol, alcohol, iso-propanol, benzene, toluene, ethyl acetate, hydrogen, hydrogen sulfide, and sulfur dioxide.

Also most aerosol sprays, alcohol-based products, paint, thinner, solvent, adhesive, hair spray, after shave, perfume, auto exhaust (cold start), and some cleaning agents.

Information about carbon monoxide

Carbon monoxide is a colorless, odorless, and tasteless poison gas that can be fatal when inhaled. CO inhibits the blood's capacity to carry oxygen.

Periodically review this alarm manual and discuss your CO alarm emergency procedure with all members of your family. Never ignore a CO alarm. A true alarm is an indication of potentially dangerous levels of CO. CO alarms are designed to alert you to the presence of CO before an emergency - before most people would experience symptoms of CO poisoning, giving you time to resolve the problem calmly.

Determine if anyone in the household is experiencing symptoms of CO poisoning. Many cases of reported CO poisoning indicate that while victims are aware they are not well, they become so disoriented they are unable to save themselves either by exiting the building or calling for assistance. Also, young children and household pets may be the first affected. You should take extra precautions to protect high-risk persons from CO exposure because they may experience ill effects from CO at levels that would not ordinarily affect a healthy adult.

Symptoms of CO poisoning

The following common symptoms are related to CO poisoning and should be discussed with ALL members of the household:

- **Mild exposure** = Slight headache, nausea, vomiting, fatigue (often described as "flu-like" symptoms).
- **Medium exposure** = Severe throbbing headache, drowsiness, confusion, fast heart rate.
- **Extreme exposure** = Unconsciousness, convulsions, cardio-respiratory failure, death.

If you experience even mild symptoms of CO poisoning, consult your doctor immediately.

Conditions that can produce carbon monoxide

- Excessive spillage or reverse venting of fuel burning appliances caused by:
 - Outdoor ambient conditions such as wind direction and/or velocity, including high gusts of wind; heavy air in the vent pipes (cold/humid air with extended periods between cycles).
 - Negative pressure differential resulting from the use of exhaust fans.
 - Simultaneous operation of several fuel burning appliances competing for limited internal air.
 - Vent pipe connection vibrating loose from clothes dryers, furnaces, or water heaters.
 - Obstructions in or unconventional vent pipe designs which amplify the above situations.
- Extended operation of unvented fuel burning devices (range, oven, fireplace, etc.).
- Temperature inversions which can trap exhaust gasses near the ground.
- Car idling in an open or closed attached garage, or near a home.

What CO alarms can and cannot do

CO alarms provide early warning of the presence of CO, usually before a healthy adult would experience symptoms. This early warning is possible however, only if your CO alarm is located, installed, and maintained as described in this manual.

Because carbon monoxide is a cumulative poison, long-term exposures to low levels may cause symptoms, as well as short-term exposures to high levels. This unit has a time-weighted alarm, the higher the level of CO present, the sooner the alarm will be triggered.

This CO alarm can only warn you of the presence of CO. It does not prevent CO from occurring, nor can it solve an existing CO problem. If your unit has alarmed and you've provided ventilation by leaving your windows and doors open, the CO buildup may have dissipated by the time help responds. Although your problem may appear to be temporarily solved, it is crucial that the source of the CO is determined and that the appropriate repairs are made.

CO alarm have limitation. Like any other electronic device, CO alarms are not fool-proof. CO alarms have a limited operational life. You must test your CO alarm weekly, because it could fail to operate at any time.

If your CO alarm fails to test properly, or if its self-diagnostic test reveals a malfunction, immediately have the unit replaced. This alarm will not monitor CO levels while in a trouble condition.

CO alarm can only sense CO that reaches the unit's sensor. It is possible that CO may be present in other areas without reaching the alarm. The rate and ability with which CO reaches the alarm may be affected by:

- Doors or other obstructions.
- Fresh air from a vent, an open window, or other source.
- CO being present on one level of the home and not reaching a CO alarm installed on a different level. (For example, CO in the basement may not reach an alarm on the second level, near the bedrooms).

For these reasons, we recommend you provide complete coverage by placing a CO alarm on every level of the home.

CO alarms should not be used to detect the presence of natural gas (methane), propane, butane, or other combustible fuels.

Instruct children never to touch or otherwise interfere with the alarm. Warn children of the dangers of CO poisoning.

Important warning statements

This carbon monoxide alarm is designed to detect carbon monoxide from ANY source of combustion. It is NOT designed to detect smoke, fire, or any other gas.

WARNING: Carbon monoxide alarms are not smoke alarms. This carbon monoxide alarm is not a substitute for installing and maintaining an appropriate number of smoke alarms in your home. This CO alarm will not sense smoke, fire, or any poisonous gas other than carbon monoxide even though carbon monoxide can be generated by fire. For this reason you must install smoke alarms to provide early warning of fire and to protect you and your family from fire and its related hazards.

Caution: This alarm will only indicate the presence of carbon monoxide at the sensor. Carbon monoxide may be present in other areas.

WARNING: This product is intended for use in ordinary indoor locations of family living units. It is not designed to measure compliance with Occupational Safety and Health Administration (OSHA), commercial, or industrial standards. It is not suitable for installation in hazardous locations as defined in the National Electric Code.

The installation of this device should not be used as a substitute for proper installation, use and maintenance of fuel burning appliances, including appropriate ventilation and exhaust systems. It does not prevent CO from occurring, nor can it solve an existing CO problem.

WARNING: This device is designed to protect individuals from acute effects of carbon monoxide exposure. It may not fully safeguard individuals with specific medical conditions. If in doubt, consult a medical practitioner. Individuals with medical problems may consider using warning devices which provide audible and visual signals for carbon monoxide concentrations under 30 PPM.

This carbon monoxide alarm requires a continuous supply of electrical power - it will not work without power.

This alarm has not been investigated for carbon monoxide detection below 70 PPM.

Contact information

For servicing or contact information, see interlogix.com.

For residential consumers, please contact your local security system installation company for product replacement service.

Product returns from security professionals and installers

Before you can return any product to UTC Fire & Security, you must obtain a return material authorization (RMA). This applies to all product returns, including warranty repair/replacements, non-warranty repairs, advance replacements, and credit returns.

Security Customer Services:
Phone: 888-437-3287
FAX: 503-691-7566
Email: Credits@interlogix.com

You will need to have the product and following information ready:

- Original PO number (not required for distribution partners)
- SKU/part number
- Serial number

Manufacturing information

Manufactured by Interlogix, a UTC Fire and Security company, 1275 Red Fox Road, Arden Hills, MN 55112.

Alarm procedure

Carbon Monoxide Alarm Procedure



WARNING: Activation of the CO Alarm indicates the presence of Carbon Monoxide (CO) which can kill you.

- 1) Operate the Test/Hush button;
- 2) Call your emergency services (Fire Department or 911);

PHONE NUMBER:

- 3) Immediately move to fresh air - outdoors or by an open door/window. Do a head count to check that all persons are accounted for. Do not reenter the premises nor move away from the open door/window until the emergency services responders have arrived, the premises have been aired out, and your alarm remains in its normal condition.
- 4) After following steps 1-3, if the alarm reactivates within a 24 hour period, repeat steps 1-3 and call a qualified appliance technician to investigate sources of CO from fuel burning equipment and appliances, and to inspect for proper operation of equipment.

PHONE NUMBER:

If problems are identified during this inspection, have the equipment serviced immediately. Note any combustion equipment not inspected by the technician and consult the manufacturer's instructions, or contact the manufacturer's directly for more information about CO safety and the equipment. Make sure that motor vehicles are not, or have not been, operating in a garage attached or adjacent to the residence.

Never restart the source of a CO problem until it has been corrected. Never ignore the sound of the alarm!

If the alarm is sounding, pressing the test/hush button will terminate the alarm. If the CO condition that caused the alert in the first place continues, the alarm will reactivate. If the unit alarms again within six minutes, it is sensing high levels of CO which can quickly become a dangerous situation.